

SPECIFICATIONS

The 8030 High School Competition Discus Cage consists of six painted steel net poles with ground sleeves, a vinyl coated net support cable to reduce net sag, and a weather treated nylon net. The poles are 14 gauge, 2 1/2" square steel tube finished with white powder coat paint. Each pole stands in a 20" deep ground sleeve. The net is 180 lb. test nylon which has been weather treated for longer life. Eighteen inch steel flip arms secure the 14' by 56' net at the front two poles with ground stakes used at the back poles. An optional 8' tall barrier net is available with attaching hardware.

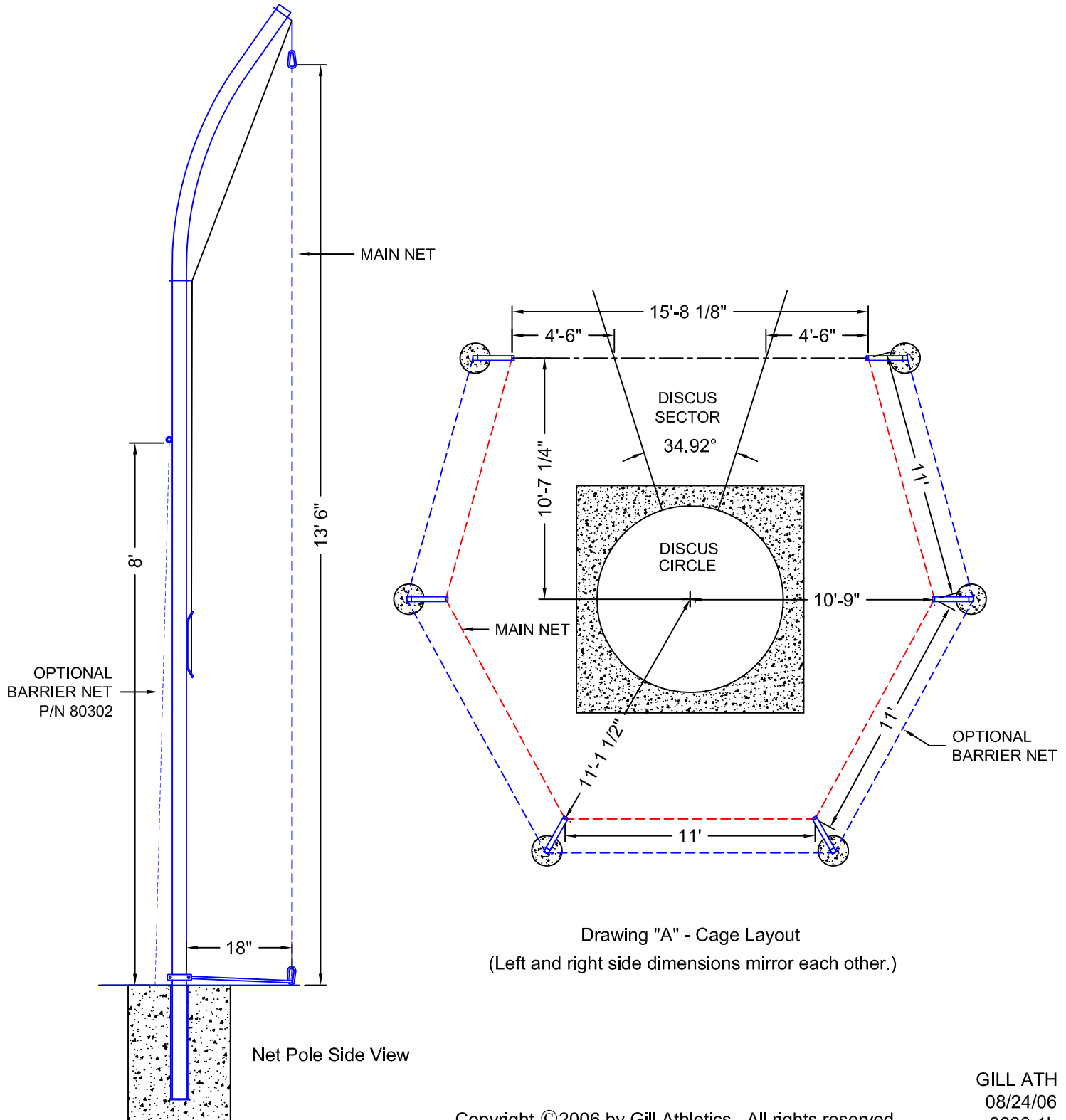

INSTRUCTIONS FOR GROUND SLEEVES

1. Stake out and mark with string the sector center line crossing the circle center. Stake out a second line perpendicular to the sector center line at the circle center. Measure and mark the sleeve centers for each post as shown in drawing "B" below.
2. Dig six 24" deep holes at marked locations. The minimum recommended diameter for these holes is 18". Soil conditions at your sight may require larger diameter concrete bases for each pole.
3. Place approximately 4" of rock in the bottom of each hole. The rock should support the sleeve at the proper height and allow water in the sleeve to drain away.
4. Mark the hole centers with crossed strings. Set each ground sleeve in place so the top edge is 1/2" above the surrounding ground level. Position the sleeves so the poles will face in the directions shown in Drawing "A", on the previous page. As the sleeves must remain vertical, secure them in place with wire and short sections of rebar.
5. Carefully pour cement around the ground sleeves. Check with a level to ensure sleeves have remained vertical. The concrete should slope away from the top edges of the sleeves to ground level to help keep water and debris out of the sleeves.

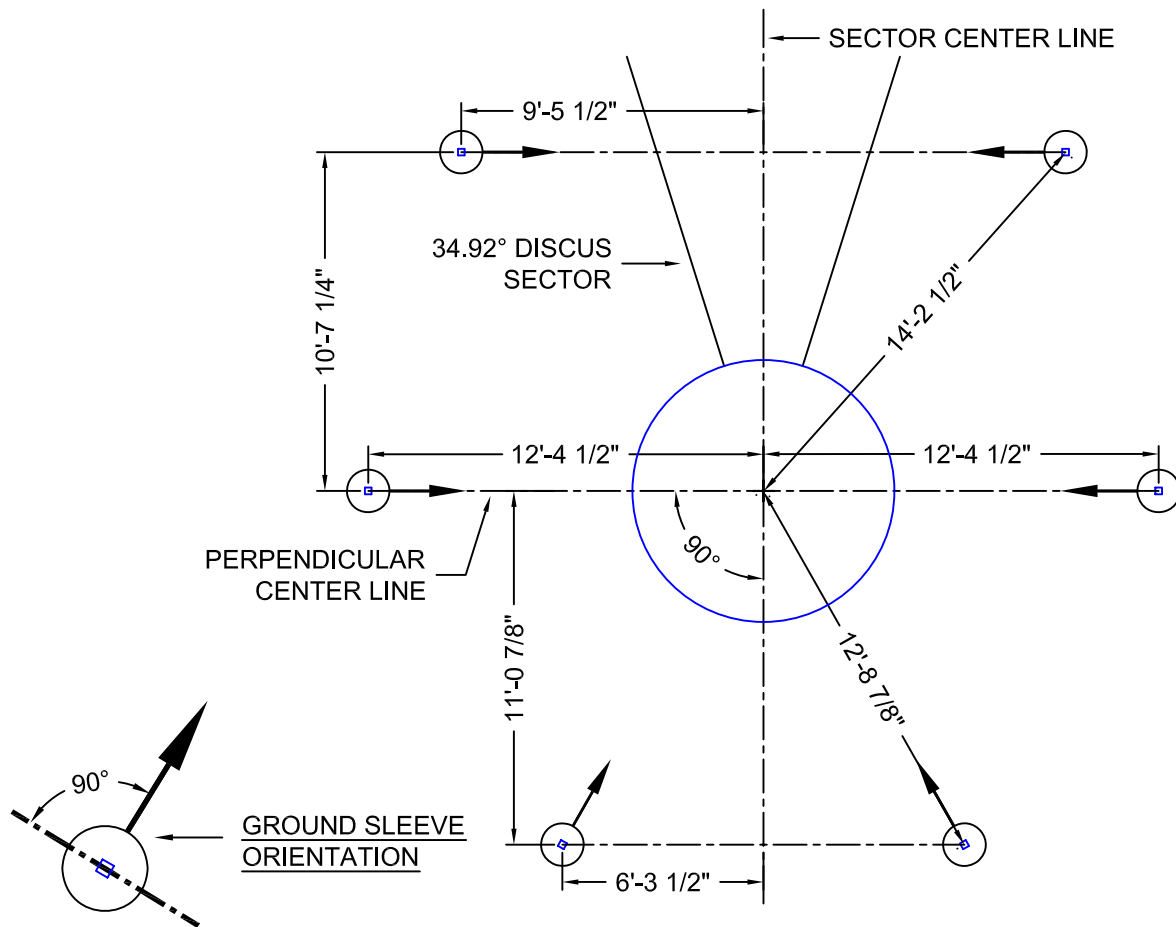

Drawing "B" - Sleeve Placement
(Left and right side dimensions mirror each other.)

NOTICE: All installations should be conducted by experienced contractors and in accord with all applicable codes, laws and regulations. Suggested instructions herein are illustrative only and should be adapted to suit local requirements. Gill Athletics is not responsible for the manner in which these products are installed.

INSTRUCTIONS FOR ASSEMBLY AND NET

1. Lay each pole flat on the ground and assemble parts as shown below. Be sure the eye bolts are positioned so the rope will pass through them freely. Set the assembled poles into the ground sleeves with the offset pointing inward. Install the front pole flip arms as shown below. Lower the net hook to the ground and tie off the rope.

2. To minimize sag, the net is supported by a vinyl coated steel cable. To install the cable, weave it in and out through every 5th net opening just below the top edge of the net. When finished, the loops at each end of the cable should be even with the ends of the net.

3. To ensure the net is evenly spaced when it is installed, mark each hook position on the net according to the diagram below. Stretch the net out flat and stake one upper corner to the ground along with the end of a 100 ft. long measuring tape. Stretch the net, cable, and tape and stake the corner to hold it's position next to the tape. Mark the top of net and the cable at the dimensions shown.

4. Lay out the net inside the cage poles with each marked position next to the appropriate net rope hook. At each position hook both the net binding and the cable. At each end be sure the hook is through the cable loop.

5. Raise the net to the top of the poles and tie off the ropes. At the base of the front poles, hook the bottom corner of the net to the flip arm. A sand bag or other weight can be placed on the arm to increase the arms resistance. If you desire, additional net flip arms can be purchased. At the rear poles, use the net stakes to hold the bottom of the net in place on the ground. The bottom 6" of the net is supposed to lay on the ground to help trap a discus.

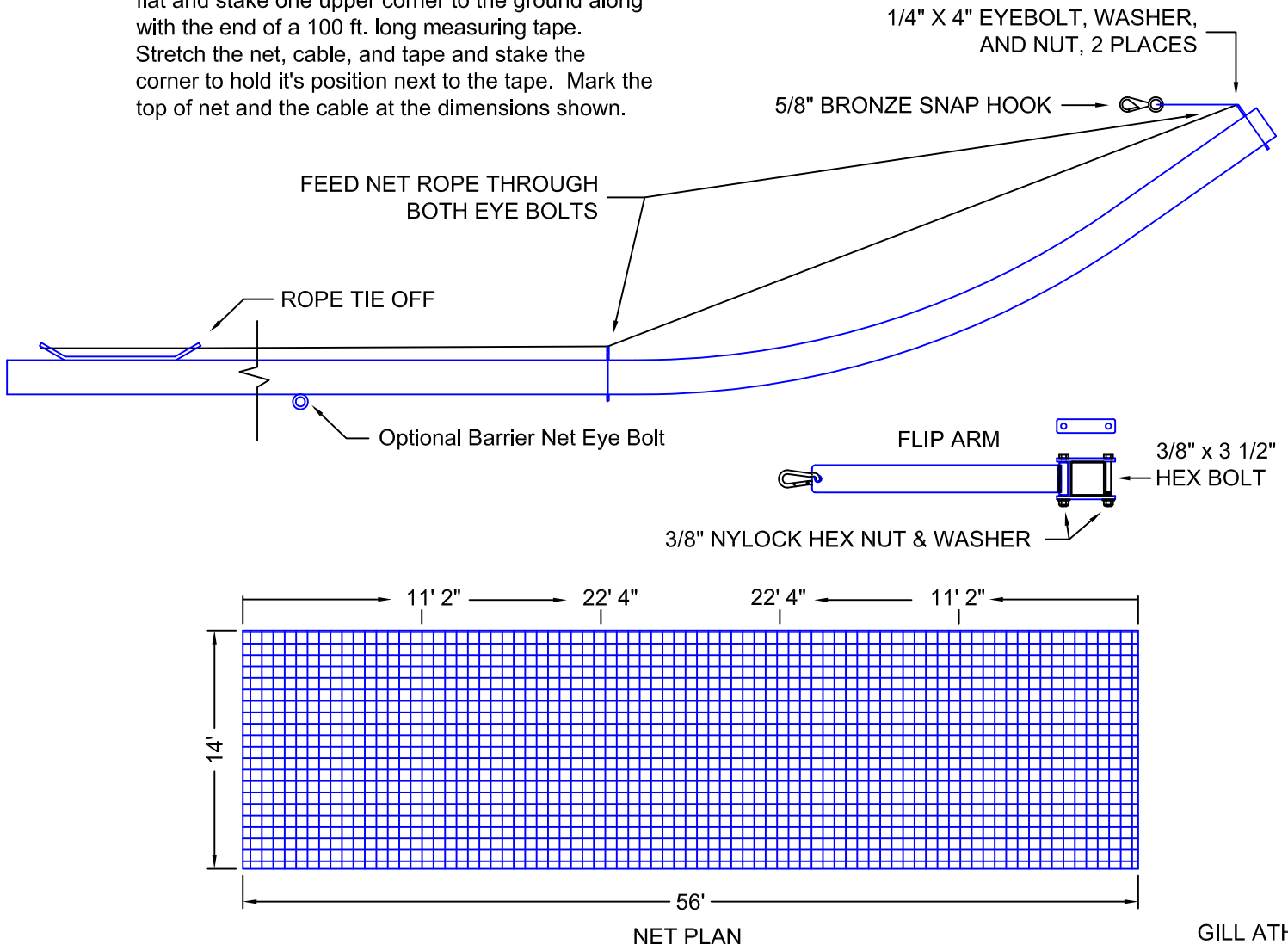



www.gillathletics.com
800-637-3090

THROWING CAGE INSTALLATION OF WARNING SIGNS

For the protection of athletes, spectators, and coaches install warning signs according to the diagram below.

Attach signs (M2322) to the cage net with the included 1.25" rings (M1250) in each corner. Signs should face away from the cage toward spectators.

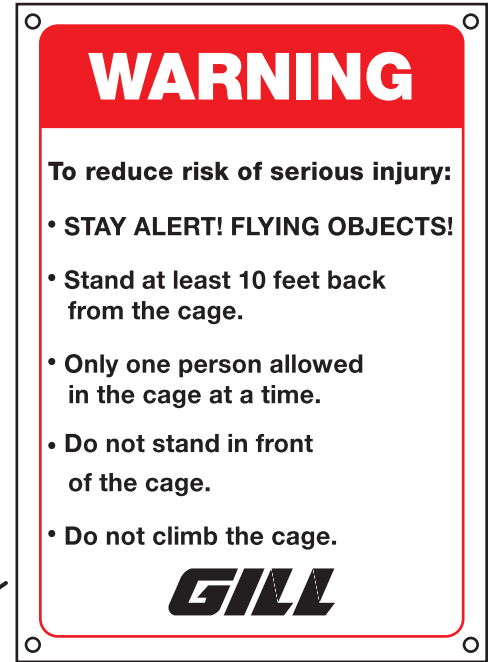

Center Back: Attach sign to the outside of the net at eye level in the middle of the back of the cage.

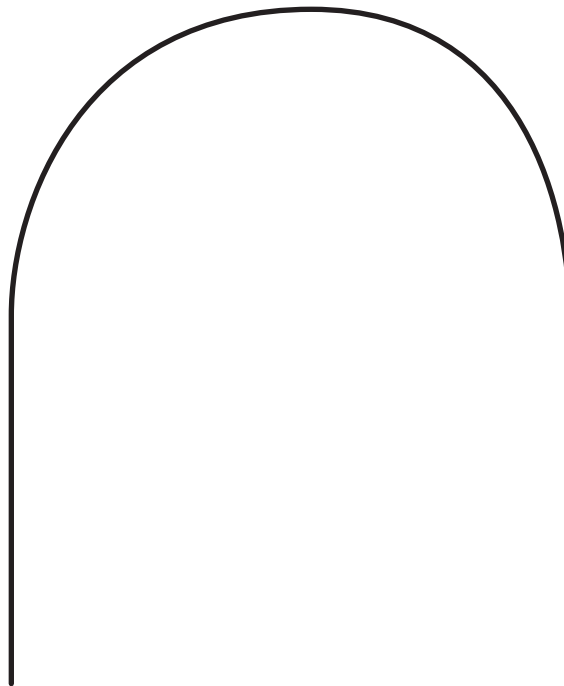

Left Front Side: Attach sign to the outside of the net at eye level near the front left side of the cage.



Right Front Side: Attach sign to the outside of the net at eye level near the front right side of the cage.





www.gillathletics.com
800-637-3090

DISCUS CAGE BARRIER NETS INSTALLATION

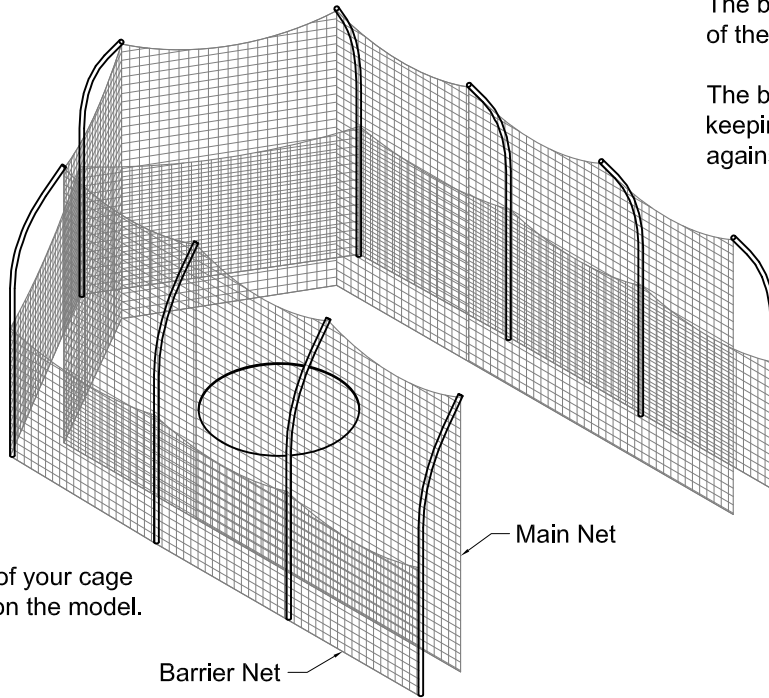

The barrier net wraps around the outside of the cage poles and is 8 feet tall.

The barrier net improves safety by keeping spectators from standing up against the outside of the main net.

The size and layout of your cage will vary depending on the model.

Main Net

Barrier Net

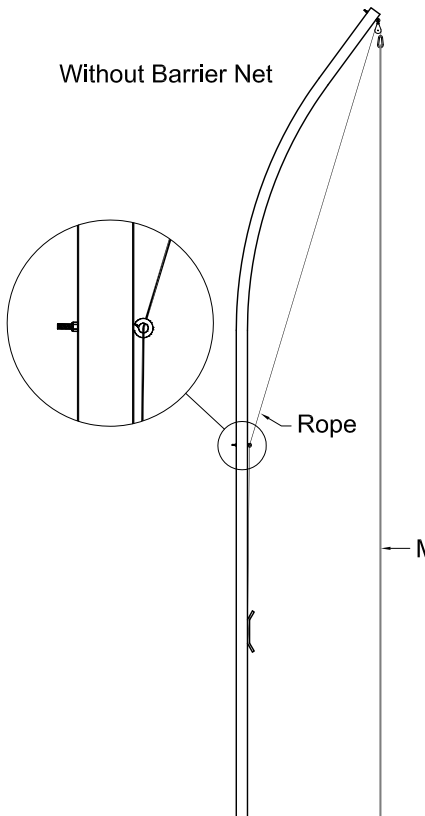

To install the barrier net remove the rope guide eye-bolts and re-install them reverse. You may have to move the bolt to a lower hole. Hang the barrier net from the eye-bolts using the snap hook (M2224).

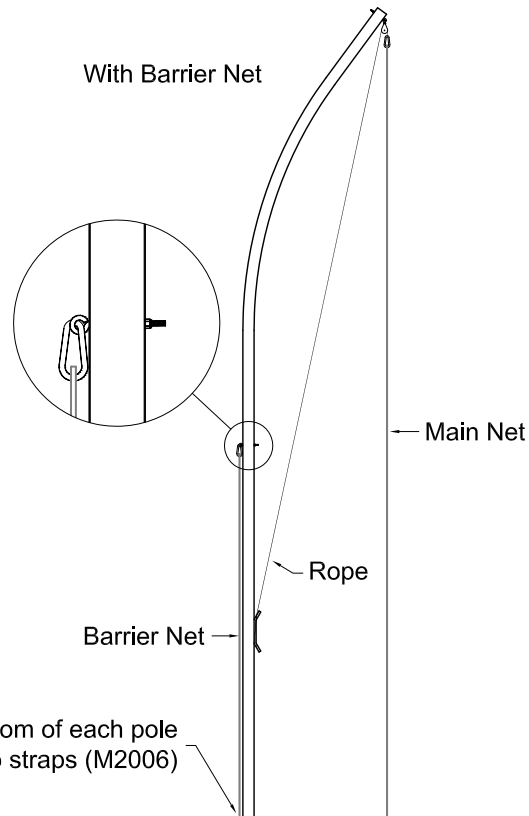

Secure the net to the bottom of each pole using the 15" velcro straps (M2006)

GILL ATH
05/30/08



www.gillathletics.com
800-637-3090

8030 - DISCUS CAGE SHIPPING LIST

8030 CAGE PARTS CHECKLIST

	SHIPPING	RECEIVING
ROLLED NET POLE.....	6 EA.....	
MAIN NET (14' x 56').....	1 EA.....	
GROUND SLEEVE	6 EA.....	

CAGE COMPONENTS KIT (BOX):

NET FLIP ARM W/HARDWARE.....	2 EA.....	
NET ROPE.....	6 EA.....	
NET CABLE, 55'.....	1 EA.....	
9" TENT STAKES.....	9 EA.....	
8030 HARDWARE BAG.....	1 EA.....	
INSTRUCTIONS.....	1 SET.....	
WARNING SIGN.....	3 EA.....	
LOOSE LEAF RING.....	12 EA.....	

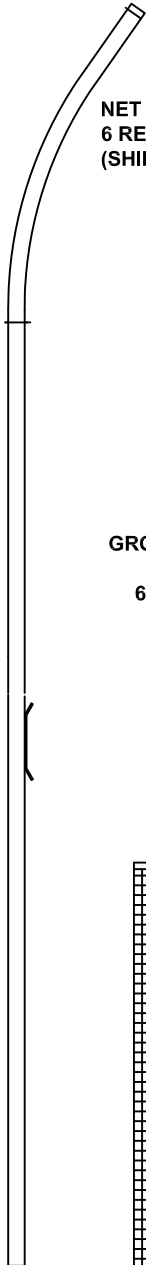

NET POLE (803020)
6 REQUIRED
(SHIPPED 2 TO A PACKAGE)

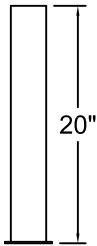

GROUND SLEEVE (80305)
6 REQUIRED

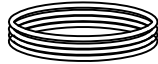

NET ROPE (80310)
6 REQUIRED

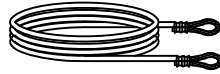

NET CABLE (803015)
1 REQUIRED

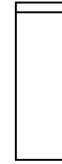

CAGE HARDWARE BAG
1 REQUIRED

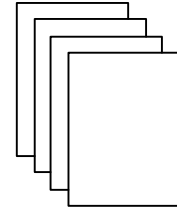

INSTRUCTIONS
1 SET REQUIRED

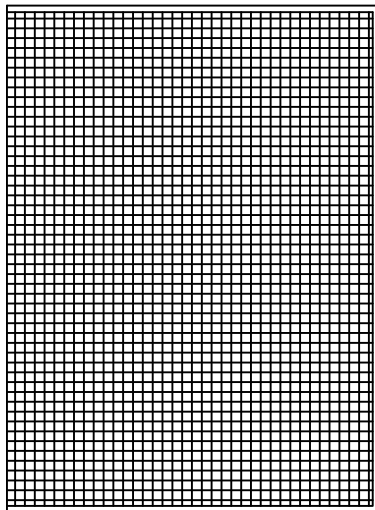

MAIN NET (M2055) - 1 REQUIRED



WARNING SIGN (M2322)
3 REQUIRED



LOOSE LEAF RING (M1250)
12 REQUIRED

9" TENT STAKES (M1242)
9 REQUIRED

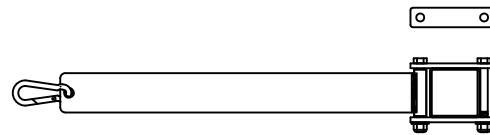

NET POLE FLIP ARM (803043)
2 REQUIRED

NOTE: ITEMS SHOWN ARE NOT TO SCALE.